

# MCF SERIES

# LINE SEIKI

## SMALL ELECTRIC COUNTER • ECONOMY TYPE

### DESCRIPTION

Economical electric totalizer with Pushbutton reset.  
 Bail, rear or base mount.  
 Compact for limited space installations.  
 Applications: Amusement Equipment,  
 Machine Tools, Measuring Devices,  
 Office Machines, Test Instruments, etc.

### MODELS

TYPE	MODELS	DIGITS	MOUNTING	WEIGHT
Additive Total Counter	MCF - 4X	4	Panel (Clip)	100 grams
	MCF - 6X	6		120 grams
Additive Total Counter	MCF - 4P	4	Panel (Screw)	100 grams
	MCF - 6P	6		120 grams

### SPECIFICATIONS

Power Source	AC 100V,110V,200V,220V <50/60 Hz convertible> / DC 12V,24V
Voltage Fluctuation	-15 - +10%
Power Consumption	AC : 3 - 4VA ; DC : 2 - 3W
Continuous Energizing	permissible
Counting Method	One pulse - One count (energizing - ½ count, unenergized - ½ count )
Counting Speed	10 Hz (maximum)
Pulse Width	50msec. minimum
Make (Duty)	1 : 1
Display	4.0 - 2.4mm (white on black background)
Reset	Manual Reset (push button)
Connection	Lead Wire (250 mm)
Operating Temperature	-5°C - +40°C (non-freezing)
Operating Humidity	85%RH maximum (non-condensing)
Test Voltage	AC1,500V for 1 minute
Insulation Resistance	50MΩ minimum (500VDC megger)
Vibration	Endurance : 16.7 Hz, double amplitude 4mm / Malfunction : 10 - 55 Hz, double amplitude 0.5mm
Shock	Endurance : 30G / Malfunction : 5G
Construction	Gray cover (Noryl)

### DIMENSIONS

#### MCF - 4X

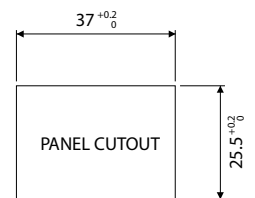
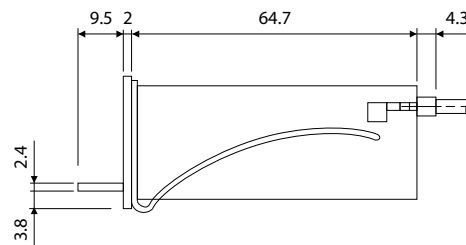
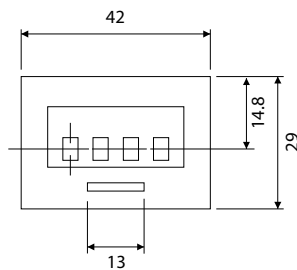

#### MCF - 6X

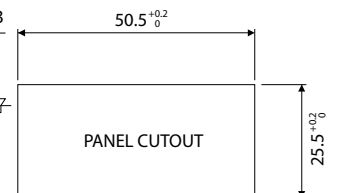
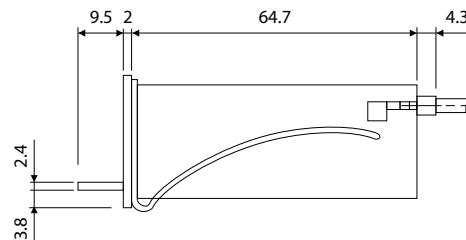
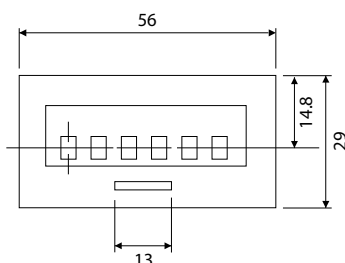

### MCF - 4P

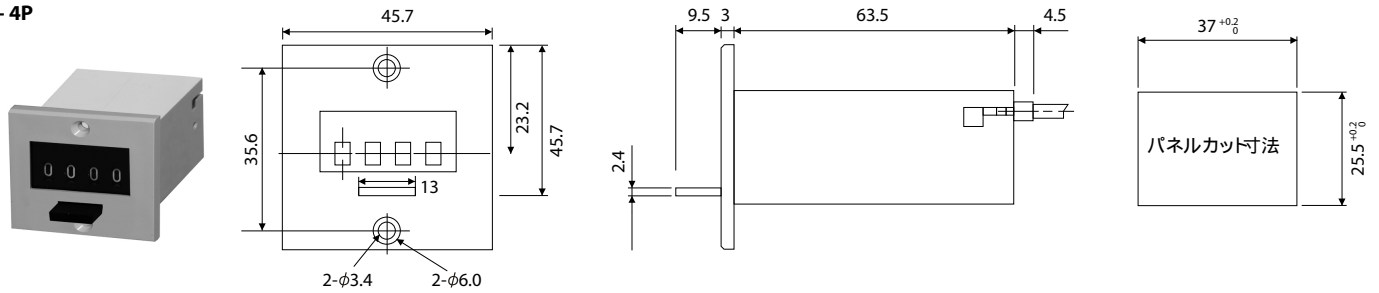

### MCF - 6P

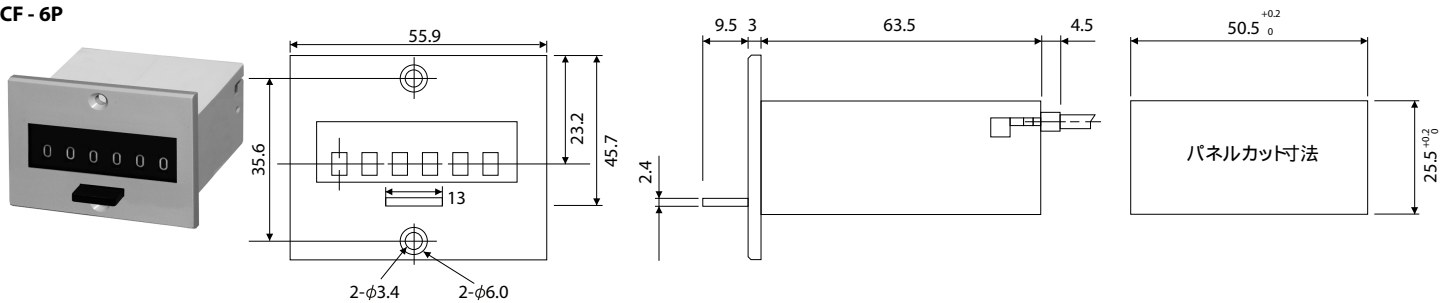

## MOUNTING

### X Type (Panel mount with clip)

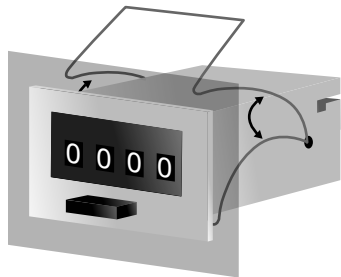

### P Type (Panel mount with screw)

